



# **GP1266 IAX2 Phone User Guide**

# INDEX

<b>1.</b>	<b>PRODUCT OVERVIEW .....</b>	<b>4</b>
<b>2.</b>	<b>FEATURES AND SPECIFICATION .....</b>	<b>4</b>
2.1.	Hardware Features.....	4
2.2.	Software Features .....	5
2.3.	Standard and Protocol.....	6
2.4.	Electric Requirements .....	7
2.5.	Size .....	7
2.6.	Operating Requirements .....	7
<b>3.</b>	<b>INSTALLATION.....</b>	<b>7</b>
3.1.	Parts List .....	7
3.2.	Connecting the Phone.....	8
<b>4.</b>	<b>GP1266 APPEARANCE .....</b>	<b>8</b>
4.1.	GP1266 IAX2 Phone Illustration.....	8
4.2.	Function Keys .....	9
4.3.	LED Functions.....	10
<b>5.</b>	<b>CONFIGURATION GUIDE .....</b>	<b>11</b>
5.1.	Configuration with Keypad .....	11
5.1.1.	Using function keys .....	11
5.1.2.	Viewing System Info .....	13
5.1.3.	Network Settings .....	13
5.1.4.	Voice Settings.....	14
5.1.5.	Protocol Settings .....	14
5.1.6.	Dialplan Settings.....	15
5.1.7.	System Settings.....	15
5.2.	Configuration with Web Browser .....	16
5.2.1.	Network Settings .....	16
5.2.2.	Voice Settings.....	18
5.2.3.	Protocol Settings .....	19
5.2.4.	Dialplan Settings.....	21
5.2.6.	System Settings.....	23
5.2.7.	Phone Book.....	25
5.2.8.	Digit Maps .....	26
<b>6.</b>	<b>USING GP1266 IAX2 PHONE .....</b>	<b>27</b>
6.1.	Placing Phone Calls .....	27
6.1.1.	Off-hook, On-hook and Speaker-phone Mode .....	27
6.1.2.	Dial Directly .....	28
6.1.3.	Redial .....	28
6.1.4.	Call from CALL HISTORY.....	28
6.1.5.	Call from PHONE BOOK.....	28
6.1.6.	Speed dial.....	29
6.2.	Answering calls .....	29
6.2.1.	Answering a call .....	29



---

6.2.2.	Call Hold .....	29
6.2.3.	Call Waiting .....	30
6.2.4.	Switch between two calls .....	30
6.3.	Blind Transfer .....	30
6.4.	Call Forward .....	30
6.4.1	Forward Unconditionally .....	30
6.4.2	Forward when busy .....	31
6.4.3	Forward when no answer .....	31
6.5.	Auto-answer .....	31
6.6.	Mute .....	31
6.7.	Do Not Disturb (DND).....	32
6.8.	Checking Voice Message .....	32
6.9.	Save/Delete a CALL HISTORY .....	32
6.10.	Edit PHONE BOOK .....	33
6.10.1.	Save PHONE BOOK .....	33
6.10.2.	Add a contact.....	33
6.10.3.	Modify a contact .....	34
6.10.4.	Delete a contact entry.....	35
6.10.5.	Delete all contact entry .....	35
<b>7.</b>	<b>FIRMWARE UPGRADE .....</b>	<b>35</b>
7.1	Manually upgrade.....	35
7.1.1.	Select upgrade item.....	36
7.1.2.	Locate upgrade file .....	36
7.1.3.	Start upgrade .....	36
<b>8.</b>	<b>LOAD AND STORE FACTORY SETTINGS.....</b>	<b>37</b>
8.1	Load Defaults Settings .....	37
8.2	Store Defaults Settings .....	37

# 1. PRODUCT OVERVIEW

IP is the acronym for Internet Protocol. An IP phone is a telephone which transmits voice over network based on IP protocol, for example LAN (Local Area Network), MAN (Metropolitan Area Network) and INTERNET.

The most significant feature of IP phone is transporting voice over data communication network with almost no extra cost and comparable voice quality and various supplementary services. Using IP phone, you will save tremendously on international calls and long distance calls.

GP1266 IAX2 IP phones provide an affordable IP phone system with ease of use, superior voice quality, economic physical design, advanced services, and features.

GP1266 IAX2 IP phones come with a four lines dot-matrix LCD display, ten speed dial keys and all kinds of calling features and functions. User can configure either through keypad or web browser.

## 2. FEATURES AND SPECIFICATION

### 2.1. Hardware Features

- Main chip—AR1688 (MCU 60MHz ;DSP 72MIPS)
- On chip SRAM—116KB
- 18 Bits High Performance On chip Codec

- Program Memory—2 MB Flash memory
- Display LCD—128 X 64 Graphics Dot.
- Ethernet Port—2X 10/100M Connectors
- Power Over Ethernet (POE) (Optional)

## 2.2. Software Features

- DHCP support for LAN or Cable modem
- PPPoE dialup
- Built in web server for configuration and upgrade
- On phone menu for configuration through keypad
- Automated provisioning of firmware and configuration via HTTP
- Manual upgrade firmware via HTTP;
- Multiple audio codec support:  
PCMU;PCMA;G.726-32;GSM6.10;iLBC;Speex;G.729
- VAD(Voice Activity Detection)
- CNG (Comfort Noise Generation)
- Dynamic Jitter Buffer
- G.165/168 compliant 32ms echo cancellation
- Tone generation and DTMF generation
- Call Hold with Music On Hold Support
- Call Waiting
- Call Transfer (Blind)

- Call Forwarding – Unconditional, No Answer, On Busy
- Auto-Answer
- Do-Not-Disturb
- Configurable Dial Plan Support
- Phone Book with 100 entries
- Speed Dialing Support (10 entries)
- Call History: Missed, Answered, Dialed Numbers with call time (10 each)
- Adjustable volume for both handset and speaker
- Hot Line Calling

## 2.3. Standard and Protocol

- IAX2 (Inter-Asterisk-eXchange V2)
- IEEE 802.3 /802.3 u 10 Base T / 100Base TX
- Power over Ethernet: IEEE 802.3af (Optional)
- Support for Layer3 Qos (Diff-Serv) and Layer 2 Qos (802.1P/Q)
- PPPoE: PPP over Ethernet
- TCP/IP: Transmission Control Protocol / Internet Protocol
- ARP: Address Resolution Protocol
- ICMP: Internet Control Message Protocol
- DHCP: Dynamic Host Configuration Protocol
- DNS: Domain Name Server

- TFTP: Trivial File Transfer Protocol
- HTTP: Hyper Text Transfer Protocol
- SNTP: Simple Network Time Protocol
- Syslog: The BSD syslog Protocol

## 2.4. Electric Requirements

- Voltage: 48V DC (POE Type); 5V AC/DC
- Power: 4.5W (max.)

## 2.5. Size

238 x 188 x 70 mm (L x W x H)

## 2.6. Operating Requirements

- Operation temperature: 0 to 45° C (32° to 113° F)
- Storage temperature: -30° to 85° C (-22° to 185° F)
- Humidity: 10 to 90% no dew

# 3. INSTALLATION

## 3.1. Parts List

Check this following list before installation to make sure that you have received all items. If any item is not included in the package, please contact the distributor.

- 1) One GP1266 IAX2 Main Case
- 2) One Handset
- 3) One Universal Power Adapter
- 4) One product qualification and guarantee
- 5) One User Guide CD-ROM
- 6) One RJ-45 Ethernet cable

## 3.2. Connecting the Phone

1. Connect handset to base: insert the handset cord into a handset cord jack on the left side of the base.
2. Connect the phone to Network: plug the RJ-45 Ethernet cable into the Ethernet Jack. Plug the other end of the cable into HUB or switch.
3. Power on the phone: plug one end of the power cord adapter into the power connector on the phone. Then plug the other end of the power cord adapter into the appropriate wall outlet.

# 4. GP1266 APPEARANCE

## 4.1. GP1266 IAX2 Phone Illustration

- **GP1266 IAX2 Phone Front Illustration** (Refer to Fig 4.1.1):

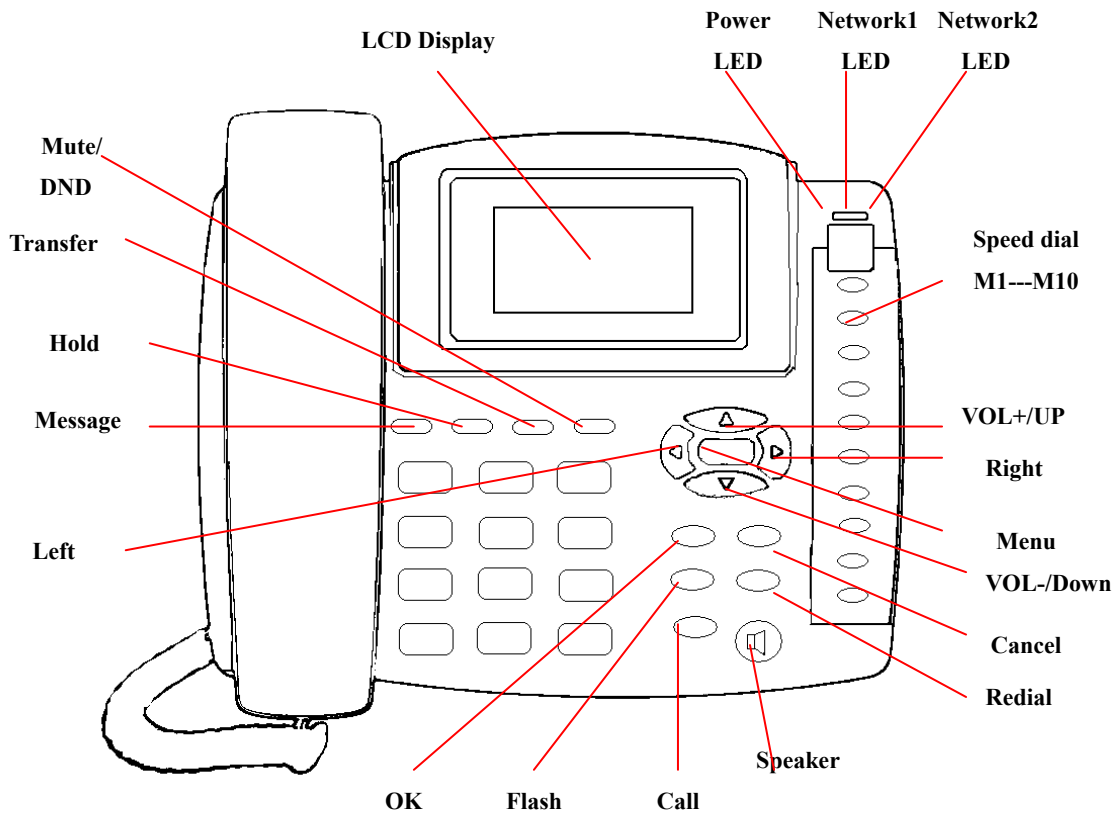

Fig 4.1.1 GP1266 Phone Front

● **GP1266 IAX2 Phone Back Illustrations(Refer to Fig 4.1.2 )**

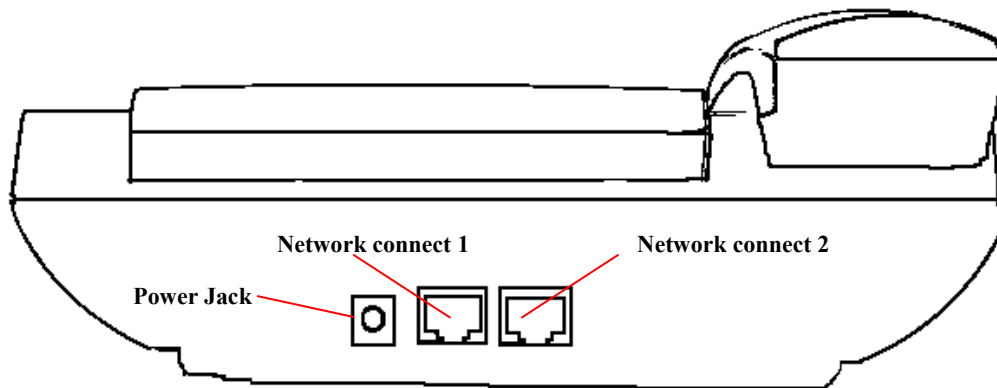







Fig 4.1.2 GP1266 IAX2 Phone Back

## 4.2. Function Keys





Keys	Function	Keys	Function
------	----------	------	----------



M1-M10	Speed-Dial key, each corresponds to a speed dial number which will be called by a single press.	MENU 	When phone is idle, press this key to enter MENU mode.
UP(▲)	Increase the output volume of handset or speakerphone.		
	In MENU mode, press this key to scroll up.		
DOWN(▼)	Decrease the output volume of handset or speakerphone.		
	In MENU mode, press this key to scroll down menu options.		
LEFT(◀)	In EDIT status, press this key to backspace.		
RIGHT(▶)	In EDIT status, press this key to shift cursor right.		
CANCEL	In MENU mode, press this key to go back to the upper level of menu.	REDIAL	Dial the last called number.
SPEAKER	Enter speakerphone mode. Press again to switch back to the handset mode.	OK	In MENU mode, enter the submenu and confirm the input.
FLASH	Press this key to accept a waiting call, start a consulting call or switch between two calls.	CALL	Place a call to the number entered.
MESSAGE 	Place a call to the pre-configured voice message number.	HOLD 	Temporarily hold the current call. Press again to unhold.
TRANSFER 	Press this key to complete a blind transfer.	MUTE/DND 	Toggle DND on and off when phone idle or mute local voice when in a call.

### 4.3. LED Functions

NETWORK1 LED	On: The connection is all right. Flashing: Data transmitting and receiving. Off: Network cable is disconnected or network error.	NETWORK2 LED	On: The connection is all right. Flashing: Data transmitting and receiving. Off: Network cable is disconnected or network error.
POWER LED	On: the power supply is all right. Off: the power supply is	HOLD LED	On: The call is on hold .

	disconnected.		
MESSAGE LED 	On: There are unread voice messages. Off: No new voice message.	MUTE/DND LED  	On: Local voice is muted when in a call; Do-Not-Disturbed is turned on when phone idle.

## 5. CONFIGURATION GUIDE

After the phone is properly installed, users can use keypad or web browser to configure its parameters.

### 5.1. Configuration with Keypad

#### 5.1.1. Using function keys

##### 1. Enter menu mode:

With the phone on-hook, press MENU  key to enter the main menu. The screen will display "Phone Book". Please refer to Fig 5.1.1.



Fig 5.1.1 Main Menu and Phone Settings Menu Structure

## **2. Scroll the menu**

Press UP (▲) , DOWN (▼) key to scroll through menu items.

## **3. Enter the submenu**

Press OK key to enter the next level of the menu.

## **4. Edit and confirm**

Press OK key to enter the **edit** mode, when current menu item has no submenu. A cursor will appear in this mode. Press OK key to confirm the input.

## **5. Delete a character and move cursor**

Use LEFT key to backspace and RIGHT key to shift cursor right in **edit** mode.

## **6. Return to the upper menu**

Press CANCEL key to go back to the upper level of the menu or exit the **edit** mode.

## **7. Exit menu mode and abort all changes**

In **menu** mode, pick up the handset or press SPEAKER key to abandon the changes and return to idle mode.

## **8. Save/Abandon the changes**

After the parameters have been modified,

1. Press CANCEL key several times to go back to the main menu, LCD will display "Save xxxx?".

2. Press OK key. The phone will save the modified contents and reboot.

Or press CANCEL key, the phone will abandon all modifications and stay in **menu** mode.

## 5.1.2. Viewing System Info

Step 1: With the phone on-hook, press MENU  key to enter the main menu.

Step 2: Press UP (▲) , DOWN (▼) key to scroll to *System Info* submenu.

Step 3: Press OK key to enter the *System Info* submenu.

Step 4: Use UP (▲) , DOWN (▼) key to scroll through the basic information of the phone, including *IP Address, Phone Number, MAC Address, Phone Model, Protocol , Language , OEM Tag and Version* .

Step 5: Press CANCEL key to go back to the upper menu.

Step 6: Use UP (▲) , DOWN (▼) key to scroll to *Phone Settings* submenu.

Press OK key to enter *Phone Settings* submenu.

## 5.1.3. Network Settings

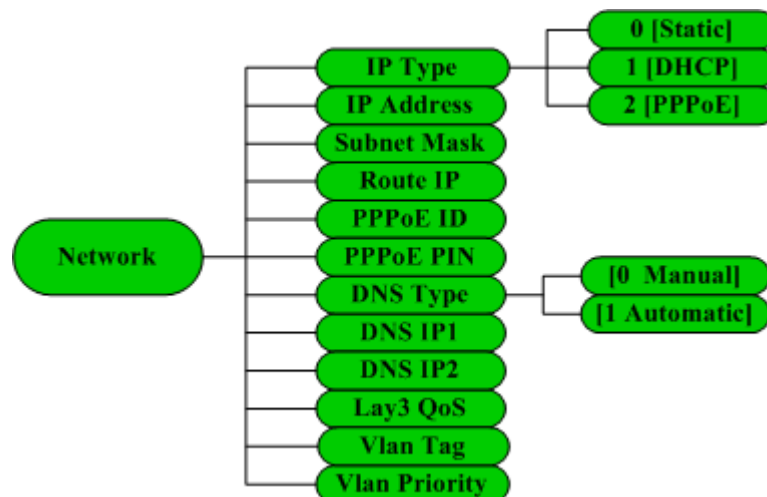

Fig 5.1.2 Network submenu

Please check the Web Configuration 5.2.2 for details about these items.

## 5.1.4. Voice Settings

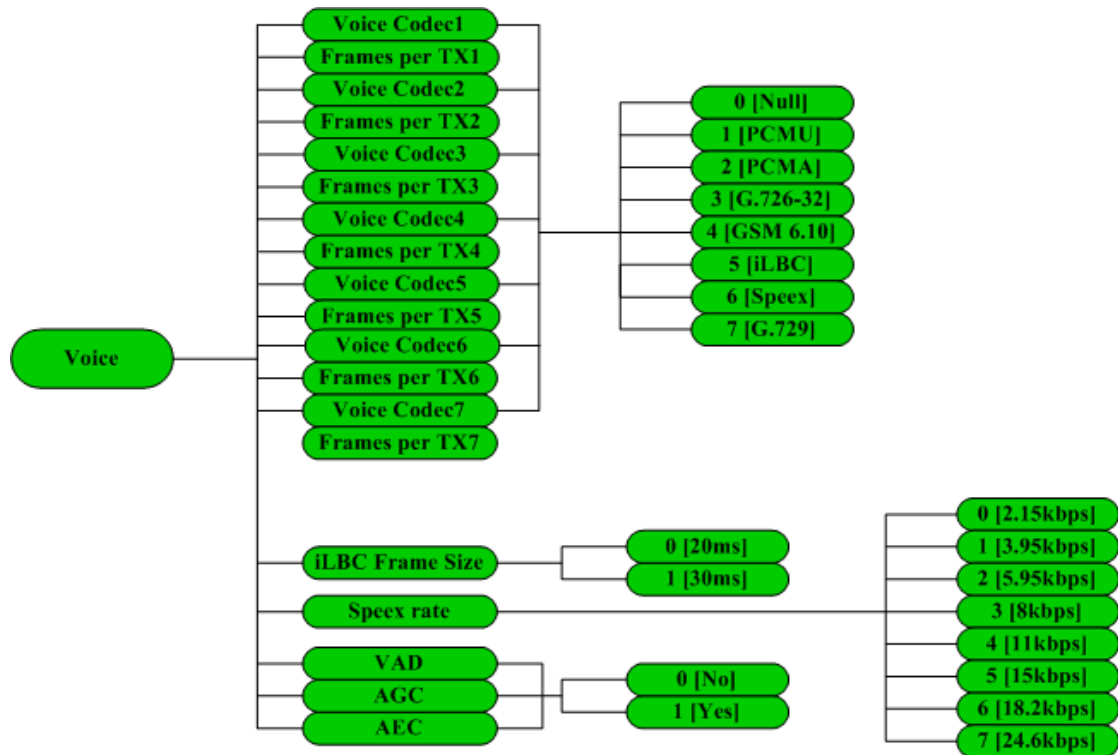

Fig 5.1.3 Voice submenu

Please check the Web Configuration 5.2.3 for details about these items.

## 5.1.5. Protocol Settings

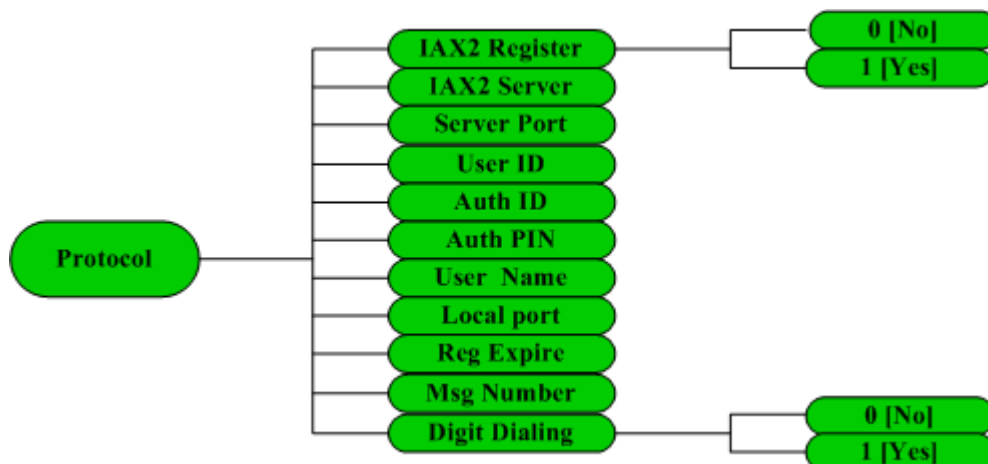

Fig 5.1.4 Protocol submenu

Please check the Web Configuration 5.2.4 for details about these items.

### 5.1.6. Dialplan Settings

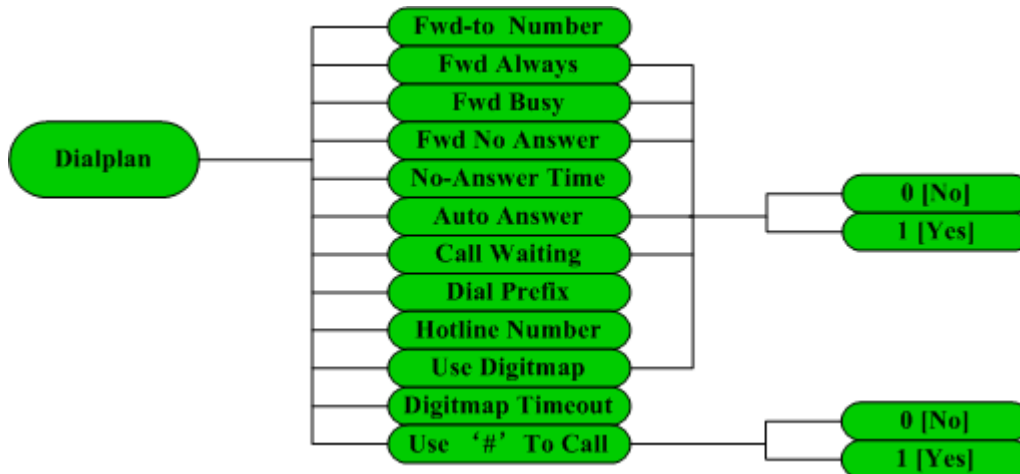

Fig 5.1.5 Dialplan submenu

Please check the Web Configuration page 5.2.5 for details about these items.

### 5.1.7. System Settings

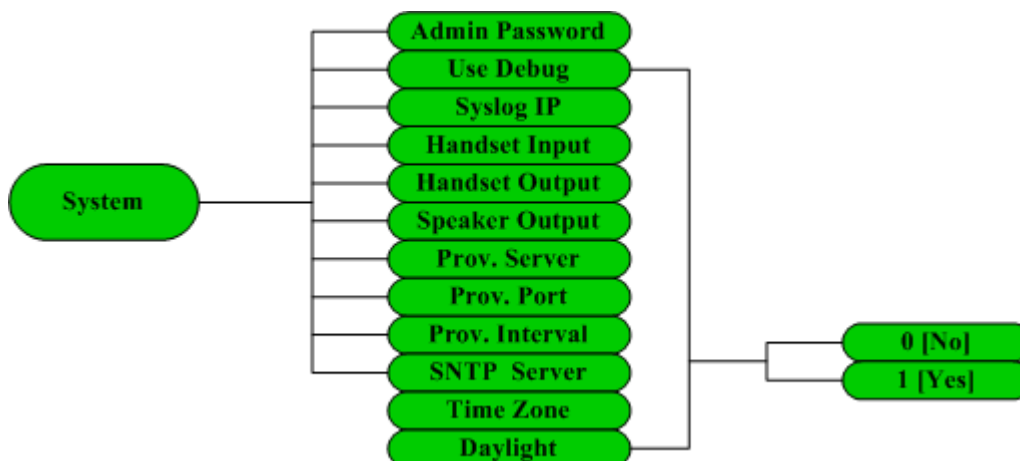



Fig 5.1.6 System submenu

Please check the Web Configuration 5.2.5 for detail about these items.

## 5.2. Configuration with Web Browser

Open a web browser and input the IP address of the phone into address bar

 <http://192.168.1.200/> (default IP: 192.168.1.200). Then put password of the phone into the following page. Default password is empty.

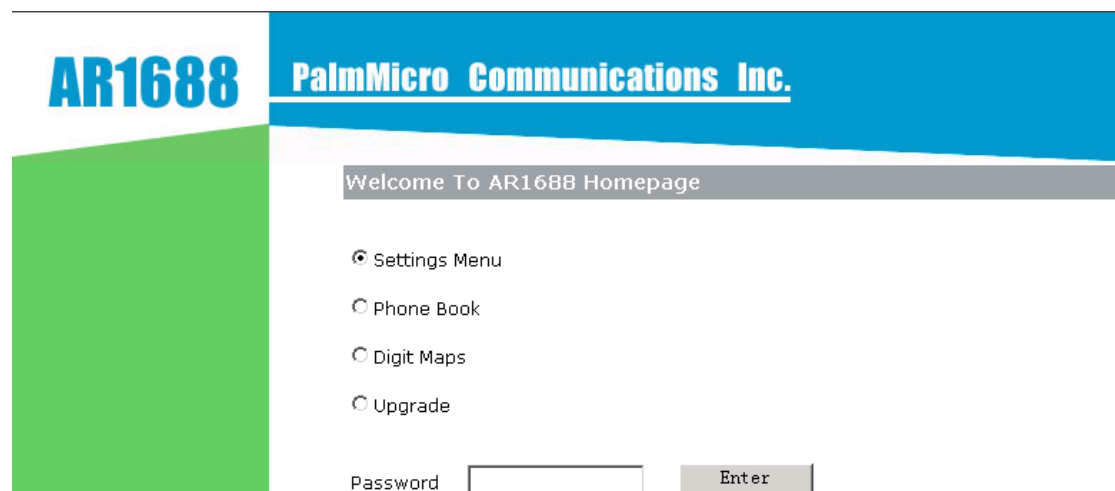



Fig 5.2.1 http settings

---

 **NOTE:** Make sure that the phone is in idle mode when viewing or setting GP1266 IAX2 Phone with web browser.

---

### 5.2.1. Network Settings

The first several lines of this page give some basic information about this phone, including Phone Model, MAC address, OEM tag and Version No..

**Network**

Voice

IAX2 Protocol

Dial Plan

System

Technical Support

### Basic Information

Phone Model: GP1266  
 MAC Address: 00-18-1F-01-00-3A  
 OEM Tag:  
 Version No.: 031021

### Network Settings

Connection Type: DHCP

IP Address: 192.168.1.123

Subnet Mask: 255.255.255.0

Default Gateway: 192.168.1.254

PPPoE User ID:

PPPoE User PIN:

Automatically get DNS server IP  
 Use following DNS server IP

Primary DNS: 202.106.0.20

Secondary DNS: 192.168.1.254

Layer 3 QoS: 0 (Diff-Serv or Precedence value)

Layer 2 QoS: 802.1Q VLAN Tag 0  
 802.1P Priority Value 0

OK
Cancel

Fig 5.2.2 Network Setting

Connection Type	<p><b>Static IP:</b> Select this item to let users to set IP address, subnet mask and router IP address manually.</p> <p><b>DHCP:</b> Have IP address and other network parameters assigned by the DHCP server.</p>
IP Address	Set IP address of the phone manually when <i>Connection Type</i> is set to <b>Static IP</b> .
Subnet Mask	Set the subnet mask of the network when <i>Connection Type</i> is set to <b>Static IP</b> .
Default Gateway	Set the IP address of the default gateway when <i>Connection Type</i> is set to <b>Static IP</b> .
PPPoE User ID	Set the User ID of the PPPoE when <i>Connection Type</i> is set to <b>PPPoE</b> .

PPPoE User PIN	Set the User PIN of the PPPoE when <i>Connection Type</i> is set to <b>PPPoE</b> .
Automatically Get DNS Server IP	Have DHCP server assign the IP address of DNS server automatically.
Use following DNS Server IP	Set the IP address of DNS server manually.
Primary DNS	Set the IP address of the first DNS server.
Secondary DNS	Set the IP address of the second DNS server.
Layer 3 Qos	When <b>Layer 3 Qos</b> is adopted, fill in the Precedence value of IP frames.
Layer 2 Qos	When <b>Layer2 Qos</b> is adopted, fill in VLAN tags (802.1Q) and priority value of Ethernet frame respectively. (802.1P)

## 5.2.2. Voice Settings

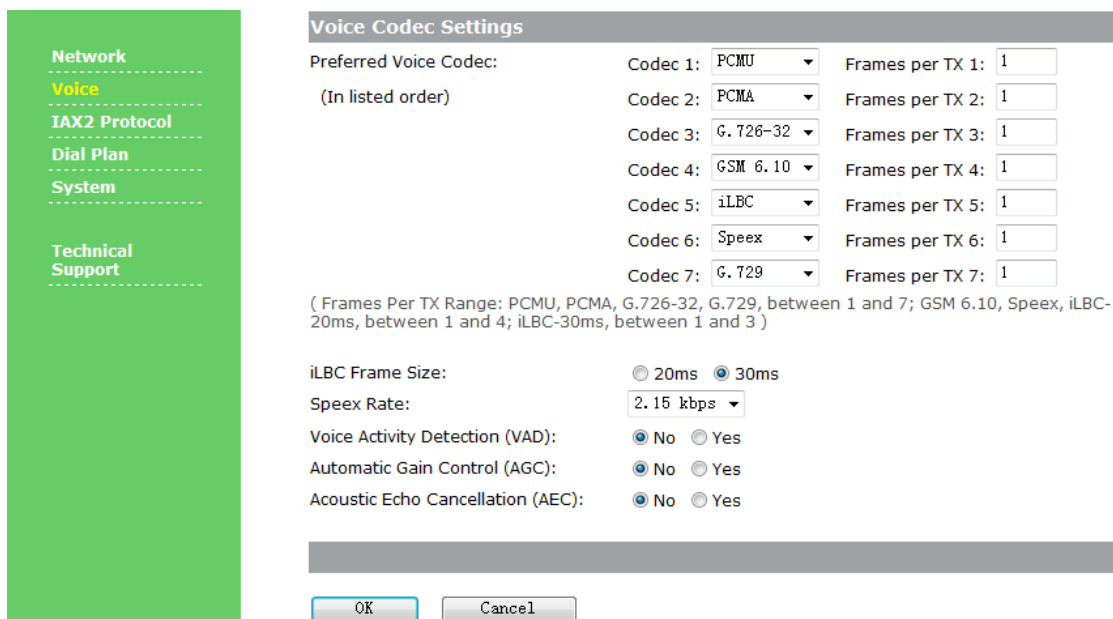

The screenshot shows a 'Voice Codec Settings' dialog box. On the left is a green sidebar with navigation options: Network, Voice (highlighted), IAX2 Protocol, Dial Plan, System, and Technical Support. The main area contains the following settings:

- Preferred Voice Codec:** (In listed order)
  - Codec 1: PCMU (Frames per TX 1: 1)
  - Codec 2: PCMA (Frames per TX 2: 1)
  - Codec 3: G.726-32 (Frames per TX 3: 1)
  - Codec 4: GSM 6.10 (Frames per TX 4: 1)
  - Codec 5: iLBC (Frames per TX 5: 1)
  - Codec 6: Speex (Frames per TX 6: 1)
  - Codec 7: G.729 (Frames per TX 7: 1)
- Footnote:** ( Frames Per TX Range: PCMU, PCMA, G.726-32, G.729, between 1 and 7; GSM 6.10, Speex, iLBC-20ms, between 1 and 4; iLBC-30ms, between 1 and 3 )
- iLBC Frame Size:**  20ms  30ms
- Speex Rate:** 2.15 kbps
- Voice Activity Detection (VAD):**  No  Yes
- Automatic Gain Control (AGC):**  No  Yes
- Acoustic Echo Cancellation (AEC):**  No  Yes

At the bottom are 'OK' and 'Cancel' buttons.

Fig 5.2.3 Voice Settings



Preferred Voice Codec	GP1266 supports up to 7 different Voice Codec types including <i>PCMU, PCMA, G.726-32, GSM 6.10, iLBC, Speex, G.729</i> .  Selecting <i>Null</i> disables the corresponding voice codec.
Voice Frames per Tx	Set the number of voice frames transmitted per packet. The suggested number is below 3(including 3) in order to reduce delay. The maximum allowable value is 8. The default value is 1.
iLBC Frame Size	Select the frame size of iLBC codec: <i>20ms</i> or <i>30ms</i> .
Speex rate	Select the rate of Speex codec: <i>2.15kbps, 3.95 kbps, 5.95 kbps, 8 kbps, 11 kbps, 15 kbps, 18.2 kbps</i> and <i>24.6 kbps</i> .
Voice Activity Detection(VAD)	Enable/disable <b>VAD</b> .
Automatic Gain Control(AGC)	Enable/disable <b>AGC</b> .
Acoustic Echo Cancellation (AEC)	Enable/disable <b>AEC</b> .

### 5.2.3. Protocol Settings



Network

Voice

IAX2 Protocol

Dial Plan

System

Technical Support

### IAX2 Protocol Settings

IAX2 Registration:       No  Yes

IAX2 Server:             (IP or URI)

IAX2 Server Port:       (Default 4569)

IAX2 User ID:          

IAX2 Authentication ID:

IAX2 Authentication PIN:

User Name:               (Optional, e.g., Woody Allen)

Local IAX2 Port:         (Default 4569)

Register Expiration:    (In seconds, default 60s)

Message Service Number:

Use Server's Dial Plan:  No  Yes

Fig 5.2.4 Protocol Settings

IAX2 Registration	Enable/disable registration with Asterisk server. To make calls through Asterisk Server, please check this box; otherwise, only IP-to IP calls is allowed.
IAX2 Server	Fill in the IP address or URI of Asterisk Server.
IAX2 Server Port	Fill in the port of Asterisk Server. The default value is 4569.
IAX2 User ID	Fill in the user account information, usually has the form of digit similar to phone number or actually the phone number.
IAX2 Authenticate ID	Fill in the IAX2 service authenticate ID.
IAX2 Authenticate PIN	Fill in the IAX2 service password.
User Name	Fill in the user name which will be displayed on LCD.

Local IAX2 Port	Fill in the local port registered with server, which send and receive IAX2 handshaking messages. The default value is 4569.
Register expiration	Set the interval of keep-alive message to Asterisk Server. The minimum value is 10, maximum value is 65535. Default is 60, with the unit of second.
Message service number	Fill in the voice message service number.
Use service's dialplan	Enable/disable service's dialplan.

## 5.2.4. Dialplan Settings

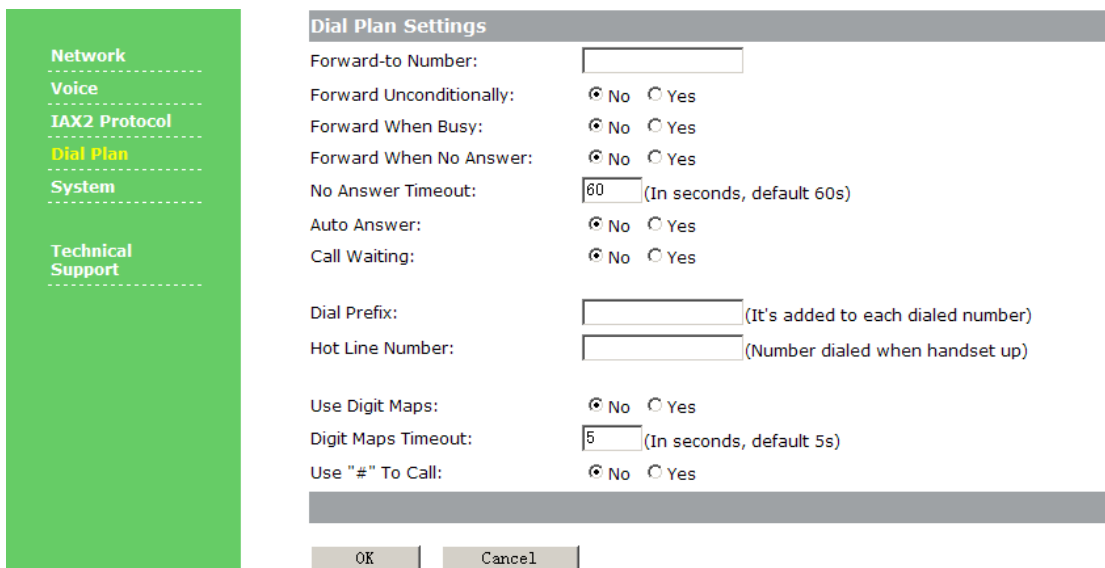

**Dial Plan Settings**

Forward-to Number:

Forward Unconditionally:  No  Yes

Forward When Busy:  No  Yes

Forward When No Answer:  No  Yes

No Answer Timeout:  (In seconds, default 60s)

Auto Answer:  No  Yes

Call Waiting:  No  Yes

Dial Prefix:  (It's added to each dialed number)

Hot Line Number:  (Number dialed when handset up)

Use Digit Maps:  No  Yes

Digit Maps Timeout:  (In seconds, default 5s)

Use "#" To Call:  No  Yes

OK Cancel

Fig 5.2.5 Dial settings

Forward-to Number	Enter the number to which you want to forward the call.
Forward	Enable/Disable unconditional call forwarding. If set to yes, all



Unconditionally	incoming calls will be forwarded to <i>Forward-to Number</i> .
Forward when busy	Enable/disable call forwarding on busy. If set to yes, the incoming call will be forwarded to <i>Forward-to Number</i> when this line is busy.
Forward when no answer	Enable/disable call forwarding when no answer. If set to yes, the incoming call will be forwarded to <i>Forward-to Number</i> when this call is not answered within a certain period of time - <i>No answer timeout</i> .
No answer timeout	Set the time in seconds before the phone answer the call automatically or forward the calls to another party.
Auto Answer	Enable/disable auto answer. If set to yes, incoming calls will be answered automatically if user doesn't answer in a certain period of time - <i>No answer timeout</i> .
Call waiting	Enable/disable call waiting. If the phone is already in a conversation when a new incoming call is received.  Enable: The new incoming call will be displayed on LCD indicating another caller is waiting. User can press FLASH key to hold current call and retrieve the new call.



	Disable: Reject the new incoming call directly.
Dial prefix	Set the prefix added to each dialed number.
Hot line number	This number is dialed out automatically as soon as the handset is picked up.
Use digit maps	Enable/disable digit maps.
Digit maps timeout	Time to wait before sending out the number user dialed when <i>Use digit maps</i> is enabled. The minimum value is 3 and the maximum value is 60, with the unit of second.
Use “#” To Call	Enable/disable “#” to equate “CALL” key

## 5.2.6. System Settings

Network

Voice

IAX2 Protocol

Dial Plan

System

Technical Support

### System Settings

Administration Password:  (Password to enter this web)

Use Debug:  No  Yes

Syslog IP:

Handset Input (0-7):

Handset Output (0-31):

Speaker Output (0-31):

Auto Provisioning Server:  (IP or URI)

Auto Provisioning Port:  (Default 80)

Auto Provisioning Interval:  (In minutes, maximum 65535 minutes)

SNTP Server:  (IP or URI, e.g, time.windows.com)

Time Zone:

Automatically Adjust Clock for Daylight Saving Changes:  No  Yes

Fig 5.2.6 System Setting

Administration Password	Password to access settings, with the maximum length of 32 characters.
Use Debug	Enable/disable output Debug message.
Syslog IP	Set the syslog server IP address.
Handset input volume	Set the input volume of the handset, ranging from 0 – 7.
Handset output volume	Set the output volume of the handset, ranging from 0 – 31.
Speaker output volume	Set the output volume of the speaker, ranging from 0-31.
Auto-provisioning Server	Fill in the URI or IP address for the auto-provisioning

	server.
Auto-provisioning port	Fill in the port of the auto-provisioning sever. Default is 80 (we use HTTP to do auto-provisioning).
Auto-upgrade interval	Set the interval of auto-upgrade in minute. The maximum value is 65535 minutes.
SNTP Server	Fill in the URI or IP address of the SNTP server.
Time Zone	Select the time zone in list box with user location.
Adjust time according to daylight saving time	Enable/disable daylight saving time.

## 5.2.7. Phone Book

Index	Name	Phone Number
001	James	6783369
002	John	8864890
003	Daniel	5543897
004	Mary	3389765

Save      Reset

Fig 5.2.7 Phone Book

The first 10 entries (001-010) in PHONE BOOK are mapped to speed dial keys (M1-M10). Press M1-M10 will immediately call these numbers.

## 5.2.8. Digit Maps

Index	Digitmap	Index	Digitmap
001	13xxxxxxxx	002	013xxxxxxxx
003	02[0-57-9]xxxxxxxx	004	03[02-689]xxxxxxxx
005	001xxxxxxxx	006	X. [T#*]
007		008	
009		010	
011		012	
013		014	
015		016	
017		018	

Fig 5.2.8 Digit Map

Digit map is a set of rules to determine when the user has finished entering digits. With digit map, users don't have to press "call" key after dialing. Fig 5.2.8 gives an example of digit map.

X represents any number between 0 and 9.

13xxxxxxxx: Any 11 digits number starting with 13.

013xxxxxxxx: Any 12 digits number starting with 013.

02[0-57-9] xxxxxxxx: Any 11 digits number starting with 02, the third number could be any digit between 0 and 5 and between 7 and 9.

03[02-689] xxxxxxxx: Any 11 digits number starting with 03, the third number is 0, between 2 and 6, 8, 9.

T represents the time to wait after the user dialed the last digit and its value is defined in *Digit Maps Timeout* option. The minimum value is 3; maximum value

is 60, with the unit of second.

X.T: Any digit number. The number is sent out in T seconds after user dialed the last digits.

X. [T#\*]: Any digit number ended with \* or # or after T seconds of waiting.

If the number entered matches an item in the digit map perfectly, or it doesn't match any item at all, this number will be sent out immediately.

---

 **NOTE** About the detail of digit map, refer to RFC3435 2.1.2.

---

## 6. USING GP1266 IAX2 PHONE

### 6.1. Placing Phone Calls

#### 6.1.1. Off-hook, On-hook and Speaker-phone Mode

With GP1266 on-hook, it can switch to the off-hook mode by picking up the handset. Press SPEAKER key and put down handset, the phone switches to the speaker-phone mode.

With GP1266 on-hook, press SPEAKER key to enter the speaker-phone mode.

The SPEAKER LED on the phone is turned on when the phone is in speaker-phone mode. Pick up handset to switch to off-hook mode.

## 6.1.2. Dial Directly

1. Pick up handset or press SPEAKER key.
2. Dial the desired number or IP address (Press \* for“. “).
3. Press CALL to complete the call.

To make a direct IP address call, disable the” IAX2 Registration” option.

## 6.1.3. Redial

1. Pick up handset or press SPEAKER key.
2. Press REDIAL key to dial the last call.

## 6.1.4. Call from CALL HISTORY

1. Press MENU  key. Scroll to “Call History” and press OK key to select the desired call record type: “Missed Calls”, “Received Calls” and “Dialed Numbers”.
2. Press OK key to view the detailed information of each call record. The first line is the time of the call, and second line is the name and number of the other party. Scroll to the desired call record.
3. Press OK key to select the action you are going to take on this record.

When “Call ?” is displayed on LCD, press OK key to make the call.

## 6.1.5. Call from PHONE BOOK

1. Press MENU  key. Scroll to “Phone book” and press OK key to enter.

Room 1004, Building 2, Phoenix Building, 2008 ShenNan Ave., Futian District,Shenzhen ,China

2. Scroll to the desired contact and press OK key to select the action to be taken next.

3. Scroll to “Call ?” item and press OK key to call this contact.

## 6.1.6. Speed dial



When phone is in off-hook or speaker-phone mode, press speed dial key (M1-M10) to call the number associated with each speed dial key. When phone is in idle mode, press M1-M10 to view the name and number information of each speed dial entry.

## 6.2. Answering calls

### 6.2.1. Answering a call

Pick up the handset or press the SPEAKER key to answer a call. Put down the handset or press the SPEAKER key to hang up.

### 6.2.2. Call Hold

During a call, press HOLD  key to put the other party on hold and send hold music to the other party. Hold LED  will light up. Press HOLD key again, the current call will release call hold.

If a call was on hold, you can put down the handset or press the SPEARKER key to close the speaker. The current call will be on hold. When pick up the handset or press the SPEARKER key again, the current call will release call hold.

### 6.2.3. Call Waiting

When **Call waiting** option is enabled, if there is a new incoming call during the current call, press FLASH key to place the current call on hold and answer the new incoming call.

### 6.2.4. Switch between two calls

Press FLASH key to switch between two calls. You can also press the hook to end current call and retrieve the on-hold call.

## 6.3. Blind Transfer

During a call, press  (TRANSFER) key to place the current call on hold and obtain the dial tone. Enter the number to which you want to transfer the call. Press CALL key to complete a blind transfer (without consultation). Blind transfer will fail if the other party is busy and there is no way to resume the original call.

If the number of you want to transfer was saved at the 001-010 entries of the Phone Book. You can press Speed dial key M1-M10 to replace the number of you want to transfer the call.

If Digitmap check box of AR168G phone was selected, you can dispense with the press CALL key to complete a blind transfer.

## 6.4. Call Forward

### 6.4.1 Forward Unconditionally

When **Forward Unconditionally** is set to yes, all incoming calls will be forwarded to **Forward-to Number**.

## 6.4.2 Forward when busy

When **Forward When Busy** is set to yes, If a new call comes when the line is busy, the new call will be forwarded to **Forward-to Number**.





## 6.4.3 Forward when no answer

When **Forward When No Answer** is set to yes, if a new call comes and is not answered in a period of time (defined by **No Answer Timeout**), the new call will be forwarded to **Forward-to Number**.

## 6.5. Auto-answer



When **Auto Answer** is set to yes, if a new call comes and is not answered in a period of time (defined by **No Answer Timeout**), the new call will be answered automatically which means the speaker phone will be automatically turned on.

## 6.6. Mute

During a call, press MUTE   key to mute local voice. The mute LED   will light up, indicating that the other party cannot hear you.

Press MUTE  key again to resume the conversation, the mute LED will turn off.

## 6.7. Do Not Disturb (DND)

When phone is on-hook, press MUTE   key to put the phone into DND status. The mute LED   will light up indicating that phone will reject all incoming calls.

To accept incoming calls, press MUTE   key again and the mute LED will turn off.

## 6.8. Checking Voice Message

A flashing message LED indicates there are new voice messages. Press MESSAGE  key to call the pre-set voice message number to check the new voice message. The message LED will be turned off after that.

## 6.9. Save/Delete a CALL HISTORY

1. Press MENU  key. Scroll to “Call History” and press OK key to enter.
2. Select the desired call record type from “Missed Calls”, “Received Calls”, and “Dialed Numbers”.
3. Delete all call records: Press OK key and scroll to “Delete ALL?” item. Then press OK to delete all call records.
4. Save a call record:
  - 1). Press OK key and scroll to “Add to Phonebook” item.
  - 2). Press OK key to confirm.

3). Press CANCEL key twice. “Save Phonebook?” will show up.

4). Press OK to save the phone book.

**E.g.**

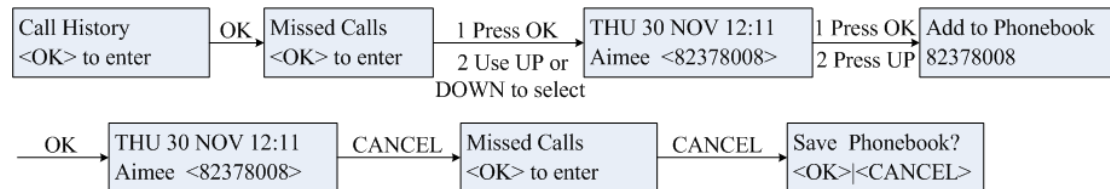

The record has been added to the phonebook and with a display:

Aimee  
82378008

## 6.10. Edit PHONE BOOK

### 6.10.1. Save PHONE BOOK

After phone book entries have been modified, press CANCEL key to back to the main menu, LCD will display “Save Phonebook?”. Press OK key to save the modifications, or press CANCEL key to reject all modifications.

### 6.10.2. Add a contact

1. Press MENU  key. Scroll to “Phone Book” and press OK key to enter.
2. Scroll to “—End of List—”. Press OK key to select “Add Newly?” item.

Or when any contact is displayed on LCD, press OK key and scroll to “Add Newly?” item.

3. When “Enter name” shows on LCD, enter the name through the keypad.

Press OK key to confirm.

Then “Enter Number” will show up on display. Enter the number through the keypad. Press OK key to confirm.

### E.g. Add Aimee to phonebook

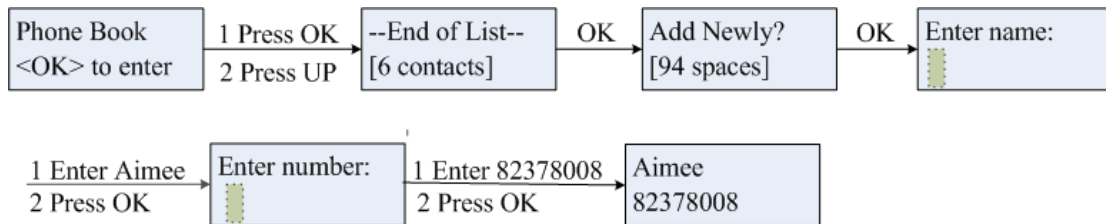

## 6.10.3. Modify a contact

1. Press MENU  key. Scroll to “Phone Book” and press OK key to enter.
2. Scroll to the desired contact and press OK key to select the action to be taken next.
3. Scroll to “Edit ?” and press OK key to enter.

When “Enter name” item displayed on LCD, enter the name through keypad.

Use UP key or LEFT key to delete unwanted input. Press OK key to confirm.

Then “Enter number” item will be displayed on LCD, enter the phone number through keypad. Press OK key to confirm.

4. Repeat step 2 and 3 to modify more contacts.

### E.g. Edit Aimee (82378008) to Kingon (100083)

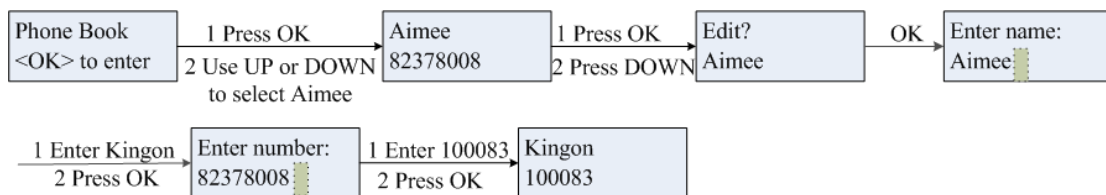

## 6.10.4. Delete a contact entry

1. Press MENU  key. Scroll to “Phone Book” and press OK key to enter.
2. Scroll to the desired contact and press OK key to select the action to be taken next.
3. Scroll to “Delete ?” and press OK key to enter.
4. Repeat step 2 and 3 to delete more contacts.

### E.g. Delete contact Aimee

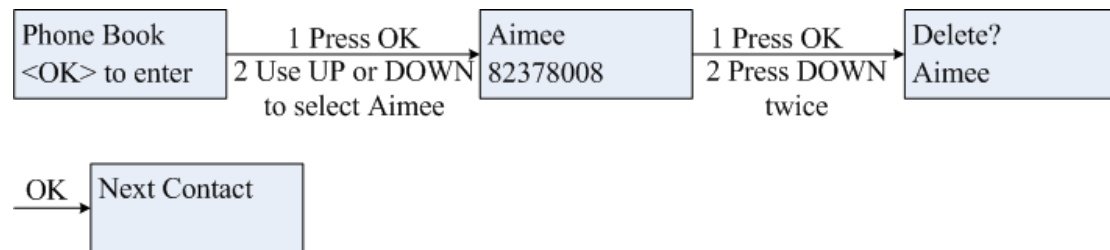

## 6.10.5. Delete all contact entry

1. Press MENU  key. Scroll to “Phone Book” and press OK key to enter.
2. Press OK key to select the action to be taken next.
3. Scroll to “Delete All?” item and press OK key to confirm.

### E.g.

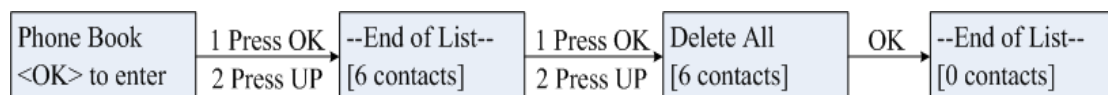

# 7. FIRMWARE UPGRADE

## 7.1 Manually upgrade

Select *Upgrade* item in the login page and enter the upgrade page below.

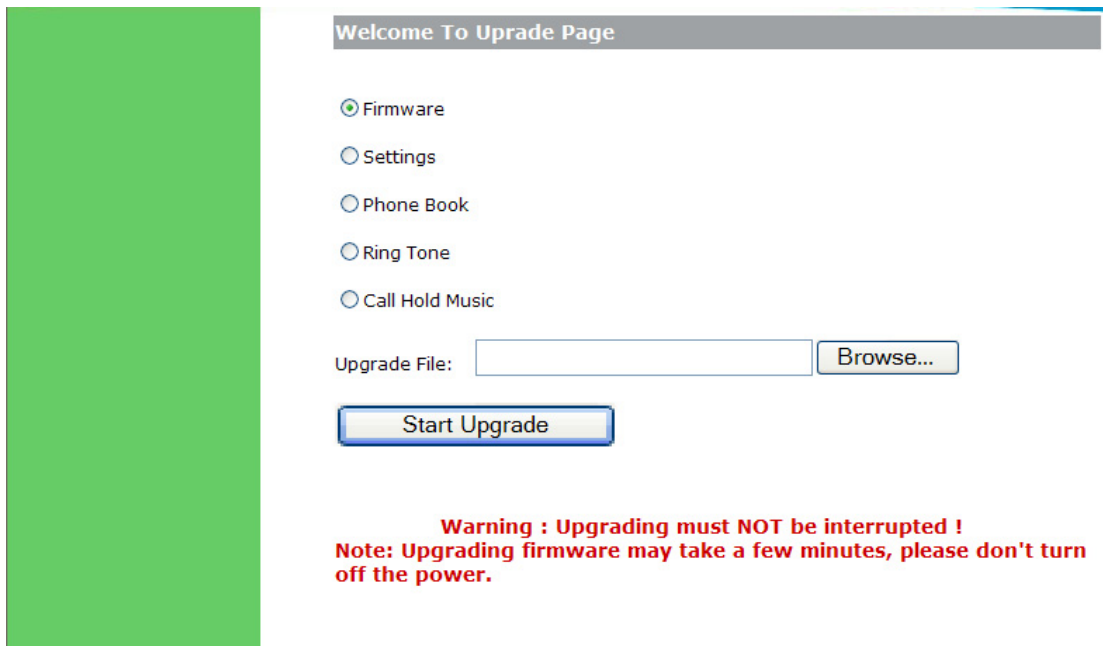

Fig 7.1.1 manually upgrade

### 7.1.1. Select upgrade item

The available options include *Firmware*, *Settings*, *Phonebook*, *Ring tone* and *Call Hold Music*.

### 7.1.2. Locate upgrade file

Use“browse.....” button to select the upgrade file. As to how to get these files, please refer to AR1688 Develop Manual.

### 7.1.3. Start upgrade

Click “*Start Upgrade*” button to start the upgrade.

---

 **NOTE:** Upgrade must NOT be interrupted! Upgrading firmware may take a few

minutes, Please don't turn off the power.

---

## 8. LOAD AND STORE FACTORY SETTINGS

### 8.1 Load Defaults Settings

1. Press MENU  key. Scroll to "Phone Settings" and press OK key to enter this submenu.
2. Scroll to "Load Defaults" and press OK key.

3.  Will be displayed on LCD. Press OK key to confirm. GP1266 IAX2 IP phone will reboot and come up with the factory default settings.

### 8.2 Store Defaults Settings

1. Press MENU  key. Scroll to "Phone Settings" and press OK key to enter this submenu.
2. Scroll to "Store Defaults" and press OK key.

3.  Will be displayed on LCD. Press OK key to confirm. GP1266 IAX2 IP phone will reboot and store the current settings to the factory default settings.



**Annex: GP1266 IP phone digital-character key map**

Keys	Once	Twice	Thrice	quartic	quintic	sixth	seventh	eighth	ninth
1	1	.	-	-	@	:	;	/	,
2	2	a	b	c	A	B	C		
3	3	d	e	f	D	E	F		
4	4	g	h	i	G	H	I		
5	5	j	k	l	J	K	L		
6	6	m	n	o	M	N	O		
7	7	p	q	r	s	P	Q	R	S
8	8	t	u	v	T	U	V		
9	9	w	x	y	z	W	X	Y	Z
0	0	space							